

COSCO®

SIMPLE

SMART

FUN



To see installation videos, scan the QR Code or visit www.coscokids.com.

©2015 Dorel Juvenile. All Rights Reserved.

COSCO®

SCENERA NEXT CONVERTIBLE CAR SEAT

Rear Facing: 5-40 lb and 19-40 in.
(2.3-18 kg and 48-101.6 cm)

Forward Facing: 22-40 lb and 29-43 in.
and at least 2 years old
(10.1-18 kg and 73.6-110 cm)

KEEP INSTRUCTIONS FOR FUTURE USE.
Read all instructions before using this
child restraint.

⚠ WARNING:

Failure to follow the warnings on the labels
and in the instruction manual can result in
serious injury or death to your child.



TETHER
Page 40



LATCH
Page 25

CUP HOLDER
Page 20



4358-6590B 5.6.15

Choosing Rear or Forward Facing

Your child's height, weight, and age determine how your child restraint should be placed in the vehicle.

⚠ WARNING: Verify your child's weight and height (do not guess) before choosing the child restraint's position.

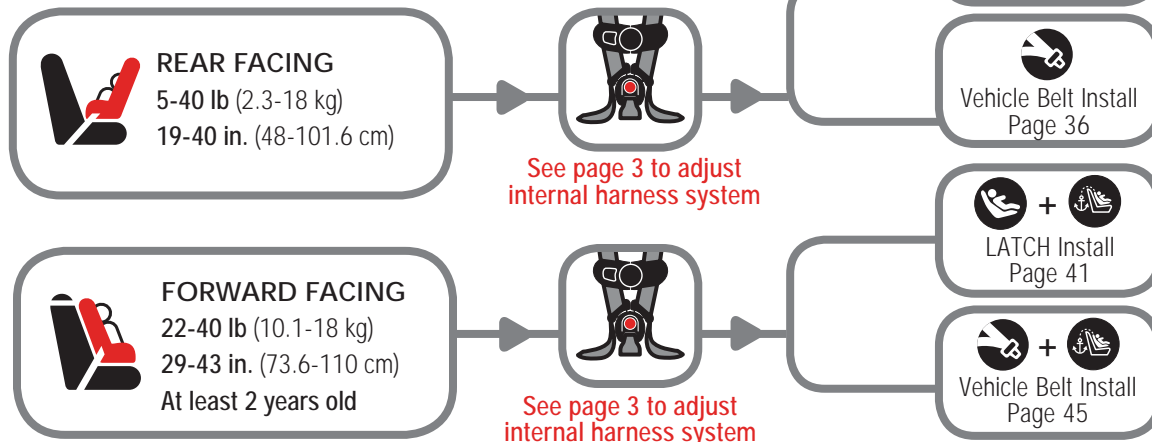

Important Symbols



Vehicle Belts

See pages 27-29 for vehicle belt information.



LATCH

See page 25 for LATCH information and storage location.



Tether

See page 40 for Tether information and storage location.



Instruction Manual Storage

See page 2 for storage location.



To help you recognize instructions which are most critical to your child's safety, we use this symbol.

Failure to follow these warnings can result in the serious injury or death of your child.

Table of Contents

Getting Started..... 1

Parts of the Child Restraint.....	1
Prepare Child Restraint to Fit Your Child	3
How Does Your Child Fit?.....	4
Changing Position of Buckle	5
Buckle Placement for Smaller Infants..	7
Changing Position of Shoulder Harness Strap.....	8
Securing Child in Child Restraint.....	11

General Use 14

Removing Harness System	14
Removing Seat Pad for Cleaning.....	16
Installing Harness System.....	17
Accessories	20



Safety Information 21

Child Restraint Use	21
Vehicle Seating Position	22
Installation in Vehicle	22



Vehicle Information..... 24

Understanding Your Vehicle.....	24
Choosing LATCH or Vehicle Belts	25
Knowing Your Vehicle Belts	27
Aircraft Information	30

Rear Facing 31

 LATCH Installation	32
 Vehicle Belt Installation	36

Forward Facing 39

 Tether Use.....	40
 LATCH Installation.....	41
 Vehicle Belt Installation.....	45

Important Information 47

Using a Locking Clip	47
Dorel Juvenile Group Information	49
Registration and Safety Notices	50
Troubleshooting	51
Replacement Parts Order Form.....	52
Warranty	54

Parts of the Child Restraint

Front View

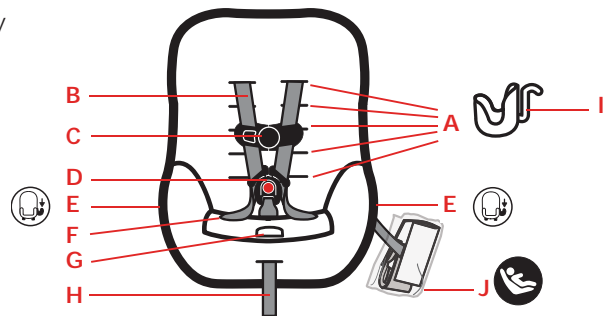

- | | |
|---|--|
| A. Shoulder Harness Slots | F. Hip Harness Slots |
| B. Harness Strap | G. Harness Release Lever (under flap) |
| C. Chest Clip | H. Harness Adjustment Strap |
| D. Buckle | I. Cup Holder (see page 20) |
| E. Cup Holder Attachment (under pad) | J. LATCH (see page 25) |

Side View

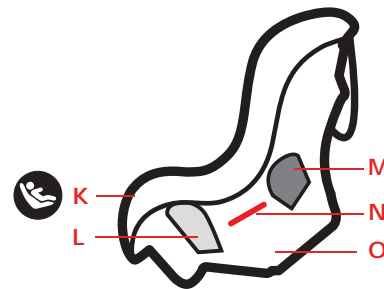

- | |
|--|
| K. LATCH Attachment for Storage (under side of shell) |
| L. Rear-Facing Belt Path |
| M. Forward-Facing Belt Path |
| N. Rear-Facing Level Line |
| O. Shell (child restraint) |

Back View

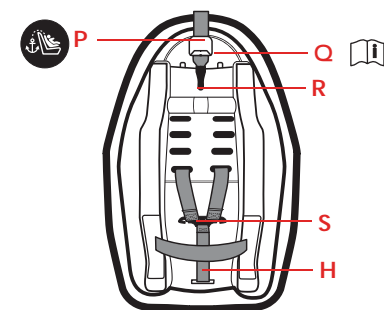

- | |
|---|
| P. Tether (see page 40) |
| Q. Instruction Manual Storage |
| R. Tether Attachment for Storage |
| S. Splitter Plate |

Prepare Child Restraint to Fit Your Child



1. Fully Loosen Harness Strap

Push down on harness release lever (under flap on front of seat pad) while pulling out on harness strap as shown.



3. Release Chest Clip

Press on chest clip release button and pull apart. Place harness strap out of the way.



2. Unbuckle Harness

Press in towards the top of the red button. Pull buckle tongues out.



4. Place Child in Child Restraint to Determine Proper Harness Fit

The child's bottom and back should be flat against the child restraint. **See page 4 for fit guidelines.**

How Does Your Child Fit?

Use the guidelines below to determine if the buckle and harness strap are in the right place for your child.

REAR FACING



Start in the 1st slot and adjust outward as your child grows. Buckle should be used in the slot closest to your child but not underneath or behind your child. 1st or 2nd slot **MUST** be used.



Always choose the shoulder harness slot closest to your child's shoulder height. Harness strap **MUST** be at or slightly below shoulders. If the lowest shoulder harness slots are above the child's shoulders, **do not** use this child restraint.

FORWARD FACING



Start in the 1st slot and adjust outward as your child grows. Buckle should be used in the slot closest to your child but not underneath or behind your child. Any slot can be used.



Always choose the shoulder harness slot closest to your child's shoulder height. Harness strap **MUST** be at or slightly above shoulders. If the highest shoulder harness slots are below the child's shoulders, **do not** use this child restraint.

To change the buckle position, see pages 5-6.
To change harness strap position, see pages 8-10.



Changing Position of Buckle



1. Turn Seat Over

Locate buckle's metal retainer on bottom of shell.



3. From Top of Seat, Pull Buckle Out of Shell



2. Rotate Metal Retainer and Push It Up Through Shell and Pad



4. Insert Buckle's Metal Retainer into Slot Closest to Child

Buckle **MUST** face out.

You **MUST** use the 1st or 2nd buckle slots when child restraint is used rear facing. Any slot can be used when forward facing.



5. Pull Metal Retainer Completely Through Pad and Shell



6. Check Buckle

Pull up on buckle to make sure it is secured.

The buckle **MUST** not pull out.

⚠ WARNING: Failure to place buckle's metal retainer completely through pad and shell can result in serious injury or death.



Buckle Placement for Smaller Infants

When using the lowest shoulder harness slots, you **MUST** make this adjustment.



1. With Buckle in the 1st Slot As Shown, Turn the Seat Over

If you need to move the buckle to the 1st slot, see page 5.



3. From Top of Seat, Lift Pad Up and Lay the Metal Retainer Flat Against the Shell As Shown



2. From Bottom of Seat, Pull Metal Retainer Towards You and Push It Up into Middle Slot As Shown



4. Replace Pad and Check Buckle

Pull up on buckle to make sure it is secured.

The buckle **MUST** not pull out.

Changing Position of Shoulder Harness Strap



1. Fully Loosen Harness Strap

Push down on harness release lever (under flap on front of seat pad) while pulling out on harness strap as shown.

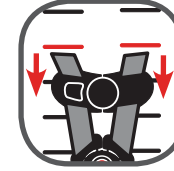

3. Pull Harness Strap Out of Shoulder Harness Slots

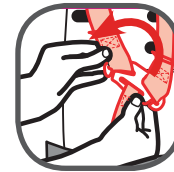

2. From Back, Remove Harness Strap Loops From Splitter Plate

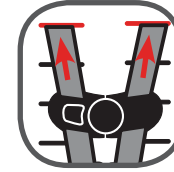

4. Rethread Harness Strap into Correct Shoulder Harness Slots For Your Child

See page 4 for fit guidelines.

continued on next page 8



If you will be using the lowest shoulder harness slots as shown, you **MUST** rethread the harness system.

To remove harness strap, see pages 14-15.

To install harness strap, see pages 17-19.

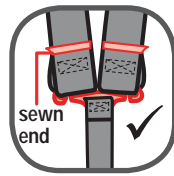

5. Attach Harness Strap Loops to Splitter Plate

Sewn ends of the harness strap loops **MUST** face towards you.

DO NOT twist harness strap or harness adjustment strap.

Make sure the harness strap loops are fitted **COMPLETELY ON** both sides of the splitter plate.

⚠ WARNINGS: Make sure the harness height is correct for your child's size.



Do not use this child restraint rear facing unless the top of your child's head is at least 1 in. (2.5 cm) below the top of the child restraint.



Do not use this child restraint forward facing if the tops of your child's ears are above the top of the child restraint.

Failure to follow these steps can result in serious injury or death.



Securing Child in Child Restraint



1. Place Child in Child Restraint

The child's bottom and back should be flat against the child restraint.

Position harness strap over child's shoulders and thighs.



3. Close Chest Clip

Insert right half of chest clip into left half and snap together.



5. Position Chest Clip

The chest clip must be placed at mid-chest (even with armpits) and away from the child's neck.



6. Check Harness Tightness

Try to pinch the harness at the shoulders vertically between index finger and thumb as shown.

If your fingers slip off, the harness is tight enough.

If you can pinch the harness strap, tighten more.

The harness strap should be snug throughout its length.



2. Buckle Harness

Push buckle tongues into buckle until you hear a "click."

Pull up on harness strap to make sure buckle is locked.

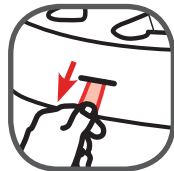

4. Tighten Harness

Pull on harness adjustment strap to tighten harness snugly.

⚠ WARNINGS: Failure to fasten and tighten the harness system correctly may allow the child to be ejected from the child restraint in a crash or sudden stop causing serious injury or death.

Do not mistake comfort for safety. Harness system must be snugly adjusted.

A snug harness strap should not allow any slack. It lies in a relatively straight line without sagging. It does not press on the child's flesh or push the child's body into an unnatural position.

To Remove Child From Child Restraint

1. Loosen Harness Strap
2. Unbuckle Harness
3. Release Chest Clip
4. Remove Child

Removing Harness System



Only remove the harness system to clean the seat pad.

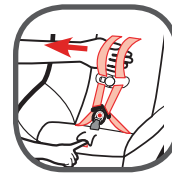

1. Fully Loosen Harness Strap

Push down on harness release lever (under flap on front of seat pad) while pulling out on harness strap as shown.



3. Pull Harness Strap Out of Shoulder Harness Slots



2. From Back, Remove Harness Strap Loops From Splitter Plate



4. Unthread Chest Clip

continued on next page 14



5. Unthread Buckle
Do not unbuckle the buckle.



6. Pull Harness Strap Out of Seat

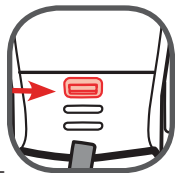

7. Turn Seat Over
Locate buckle's metal retainer on bottom of shell.



8. Rotate Metal Retainer and Push It Up Through Shell and Pad



9. From Top of Seat, Pull Buckle Out of Shell

Removing Seat Pad for Cleaning



You must remove the harness system to remove the pad from the shell. See pages 14-15.

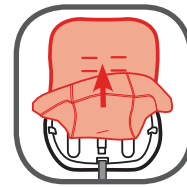

Remove Pad

Pull pad off the bottom of child restraint and remove pad.

⚠ WARNINGS: Do not use child restraint without the seat pad.

Failure to do this can result in serious injury or death.

Cleaning Pad

Machine wash separately with cold water on a gentle cycle. Do not use bleach. Tumble dry separately for 10-12 minutes on low heat. Remove immediately.

Cleaning Harness Strap

Spot clean using warm sudsy water and damp cloth.

Replacing Pad

Starting from bottom of child restraint, slip pad on shell. Pull harness adjustment strap through pad. Wrap pad around the top of shell. Install harness system, see pages 17-19.



Installing Harness System



1. Insert Buckle's Metal Retainer into Slot Closest to Child

Buckle **MUST** face out. You **MUST** use the 1st or 2nd buckle slots when child restraint is

used rear facing. Any slot can be used when forward facing.



3. Check Buckle

Pull up on buckle to make sure it is secured.

The buckle **MUST** not pull out.



2. Pull Metal Retainer Completely Through Pad and Shell

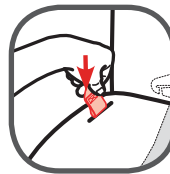

4. Rethread Harness Strap

With sewn end of harness strap loop facing the buckle, thread harness strap

down through hip harness slot.

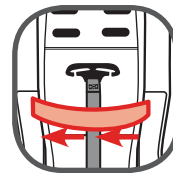

5. Pull Harness Strap Across Bottom of Shell

Harness strap **MUST** lie in front of harness adjustment strap as shown. Push harness strap up through other hip harness slot.

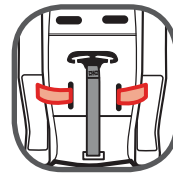

If you will be using the lowest shoulder harness slots, you **MUST** pull up front of seat pad and weave harness strap in

and out of shell as shown. Replace seat pad.

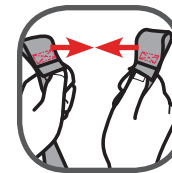

6. Make Harness Strap Even

Sewn ends of harness strap loops **MUST** face each other.

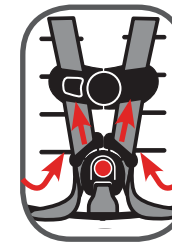

7. Thread Buckle and Chest Clip

Harness strap ends go through the **back** of buckle tongues and through the chest clip **front to back** as shown.

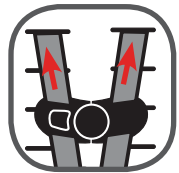

8. Thread Harness Strap Into Correct Shoulder Harness Slots For Your Child

See page 4 for fit guidelines.

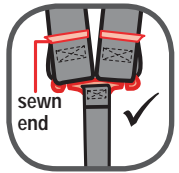

9. Attach Harness Strap Loops to Splitter Plate

Sewn ends of the harness strap loops **MUST** face towards you.

DO NOT twist harness strap or harness adjustment strap. Make sure the harness strap loops are fitted **COMPLETELY ON** both sides of the splitter plate.



⚠ WARNINGS:
Failure to place harness adjustment strap behind the harness strap as shown can result in

serious injury or death.

Harness system must be installed correctly.

Failure to follow these warnings can result in serious injury or death.

Accessories



Cup Holder

The cup holder can be attached to either side of the shell.

Pull pad off corner of shell.

Align symbol on cup holder with symbol on shell.

Hook bottom of cup holder under edge of shell.

Snap top of cup holder over edge of shell.

Replace pad.

The cupholder is dishwasher safe.

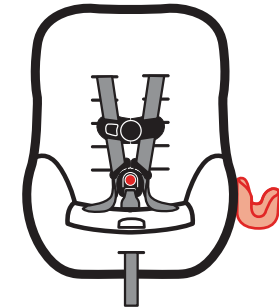
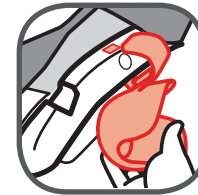
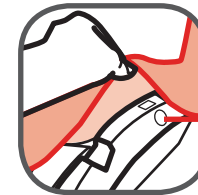



Child Restraint Use

Do not use this child restraint unless the child is 5-40 lb (2.3-18 kg) and 19-43 in. (48-110 cm).

Never take your child out of the child restraint while the vehicle is moving.

Never leave child unattended.

Placing your child in a hot child restraint may result in burns.

Do not use a child restraint with damaged or missing parts.

Do not use cut, frayed or damaged harnesses.

Do not substitute parts or try to modify the child restraint in any way.

Do not lubricate buckles and fasteners.

Do not use any child restraint accessory except those approved by Dorel Juvenile Group.

Never allow any child to play with this child restraint; it is not a toy.

Do not remove or cover up any of the warning labels or other labels on the child restraint.

Read all instructions for additional warnings.

On the side of the child restraint there is a date of manufacture label. Do not use this child restraint more than 8 years after the date of manufacture.

Vehicle Seating Position

Check the vehicle belt or LATCH belt before each use. Use only if the belt can be tightened properly and locked securely in place.

This child restraint should be securely belted in the vehicle even when not in use. In a crash or sudden stop, an unsecured child restraint could injure occupants.

Do not use a child restraint that has been in a crash. You must get a new child restraint.

Installation in Vehicle



Never install a rear-facing child restraint in the front seat of a vehicle equipped with an active passenger side frontal airbag.



Always check vehicle owner's manual for child restraint use with side airbags.

Check the vehicle owner's manual for more information about air bag/child restraint use.



Use the child restraint only on vehicle seats that face forward.



Do not use on seats that face the sides or rear of the vehicle.

Use the center seating position if possible.

For vehicles without a back seat, refer to your vehicle owner's manual.

continued on next page 22



If you are not sure where to place the child restraint in your vehicle, consult your vehicle owner's manual, contact Dorel Juvenile Group Consumer Relations Department, or visit your local Child Passenger Inspection Station. Go to <http://www.safercar.gov/cpsApp/cps/index.htm> to find your closest station.



Children are safer when properly restrained in

rear seating positions than in the front seating positions.

According to National Highway Traffic Safety Administration information, children in rear seating positions are statistically safer, whether

you have air bags, advanced air bags, or no air bags at all.

To avoid your child being seriously burned, take the following precautions:

1. Park in the shade or where sun does not directly hit the child restraint.
2. Cover the child restraint with a sheet or blanket when not in use.
3. Check for hot seat and buckles before placing child in child restraint.

To help protect your vehicle seat's upholstery from damage, use a single layer towel underneath and behind child restraint.

Understanding Your Vehicle



Your vehicle's features may be considerably different than those pictured here.

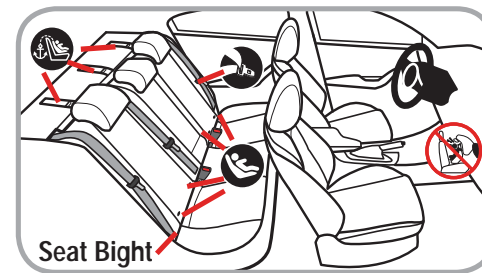

Consult your vehicle owner's manual to help identify your vehicle's specific features and locations.



Air Bags



Tether Anchors
For Tether Strap (Forward Facing Only)



LATCH Anchors
Located in the seat bight.



Vehicle Seat Belts



Choosing LATCH or Vehicle Belts

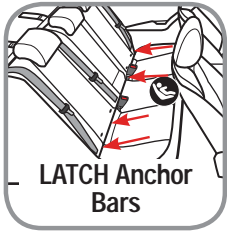

LATCH Anchor Bars

The LATCH System

LATCH (Lower Anchors and Tethers for CHildren) is a universal system for installing child restraints without using vehicle

seat belts. The LATCH system can ONLY be used in vehicles that have the LATCH anchor bars installed and designated LATCH seating positions. Most vehicles manufactured after September 2002 are equipped with LATCH. Check your vehicle owner's manual to see which seating positions may be equipped with the LATCH system.

When installing this child restraint with vehicle belts, the LATCH hooks and belt MUST be properly stored.

To store LATCH on this child restraint: When used rear facing, thread LATCH belt through forward-facing belt path. **When used forward facing**, thread LATCH belt through rear-facing belt path. Then attach hooks to attachments near rear-facing belt path as shown. Gently pull free end of belt to remove slack.

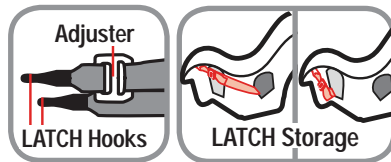

LATCH Hooks

LATCH Storage



Vehicle Belts

If LATCH is not an option, you must use the vehicle seat belt system to install the child restraint.

There are some vehicle belts that will not work with a child restraint or will require special attention.

Check your vehicle owner's manual for specific instructions.

⚠ WARNING: When used correctly the LATCH or vehicle belts are equally safe. Do not use both the LATCH belt and vehicle belts at the same time.



Knowing Your Vehicle Belts

Review your vehicle owner's manual for vehicle seat belt use with child restraints. This is your best source for information concerning your vehicle.

Not all vehicle belts will work with this child restraint. This child restraint must be tightly locked in place at all times. You must determine if your vehicle's belts are compatible with this child restraint.

Vehicle Belts



- **Automatic/Passive vehicle seat belts**

You **MUST** have a lap belt to install any child restraint. An automatic (passive) shoulder belt may or may not have a separate lap belt.

- **Do not use with inflatable seat belts**

You may need to move the child restraint to another seating location or use LATCH belts only.

- **Vehicle belts in center of the door or side panel**

You must move the child restraint to another seating location.



- **Vehicle belts that are in front of the seat bight**

You may need to move the child restraint to another seating location.

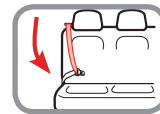

- **ELR (Emergency Locking Retractor) vehicle belts**

These belts only lock in a sudden stop or crash, and do not properly secure a child restraint alone. **To determine if you have this type of belt**, gently pull the belt all the way out of the retractor (spool), let it return several inches, then pull on it again. If it moves freely, it is an ELR belt. If it is locked and will not allow any more belt to come out, it is a switchable retractor.

If you have an ELR lap and shoulder belt, review the "Vehicle Latch Plate" section on page 29 to see if you need a locking clip.

⚠ WARNING: ELR lap-only belts MUST NOT be used with this child restraint.

- **Switchable Retractor**

These belts switch from ELR to ALR (Automatic Locking Retractor). You **MUST** have the vehicle belts in the locking mode to use them.

With a switchable retractor, pull the shoulder belt all the way out to switch the retractor into the ALR mode before tightening. Feed the slack back into the retractor while tightening.

- **ALR (Automatic Locking Retractor)**

These belts lock after pulling the webbing out and letting the belt go back into the retractor an inch or two.

With an ALR belt, pull the belt all the way out before threading through the child restraint.

continued on next page 28



Aircraft Information

Vehicle Latch Plates

• Check Latch Plates

Grasp the tongue portion of the latch plate (the part that goes inside the buckle) and pull straight out, in line with the lap belt.

If the latch plate does not slide up and down the vehicle belt, you have a locking latch plate. You should not need to use a locking clip.

Check your vehicle owner's manual to determine the best way to lock a child restraint in place and whether the latch plate or retractor will accomplish this.

If the latch plate slides up and down on the belt, and you have an ELR retractor, you **MUST** use a locking clip to install the child restraint. See pages 47-48.

You may not need to use the locking clip with a switchable or ALR retractor.

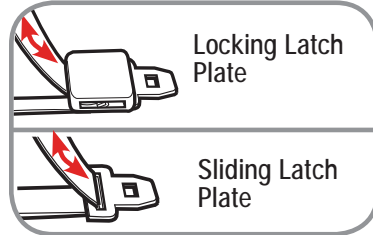

This restraint is certified for aircraft use. Install the child restraint in a window seat to avoid blocking the aisle. If the aircraft lap belt is too short, ask the flight attendant for a belt extender. Use only on forward facing aircraft seats. Contact the airline for their specific policies.

Some airlines may ask to see a label stating that this child restraint is certified for aircraft use.



There is an airplane certification label located on the side of this child restraint as shown.



Rear Facing Aircraft Installation

For rear facing installation follow pages 36-38.



Forward Facing Aircraft Installation

For forward facing installation follow pages 45-46.



Rear Facing



5-40 lb (2.3-18 kg)
19-40 in. (48-101.6 cm)



LATCH Belt



Lap/Shoulder Belt



Lap Belt



⚠ WARNINGS: Never place a child rear facing in a seating position with an active frontal air bag. This can result in serious injury or death.

This child restraint **MUST** always face the rear of the vehicle when the child is less than two years old.

LATCH Installation

⚠ WARNINGS: Do not use LATCH belts along with the vehicle lap or lap/shoulder belt. Check LATCH belt before each use. Use only if the belt can be tightened properly and securely. Do not fasten both LATCH hooks on same LATCH anchor bar in the vehicle.



When the child restraint is used rear facing, you **MUST** secure the tether hook to the storage attachment and gently tighten to remove slack. Failure to follow these warnings can result in serious injury or death.

Safety Tip

Make sure harness and buckle fit your child correctly before installing the child restraint. See pages 3-4.



Review your vehicle owner's manual for LATCH belt use and LATCH locations.



1. Remove LATCH from Storage Location



2. Route LATCH Belt Through Rear-Facing Belt Path

LATCH adjuster can be on either side.

continued on next page 32

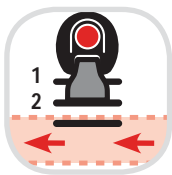

3. Reach Under Pad and Pull Hook Across to Opposite Side

Do not twist belt.

Belt **MUST** be in **front** of buckle strap. You **MUST** use the 1st or 2nd buckle slot. Do not place belt over child's legs.



5. Place Child Restraint Rear Facing in Back Seat

For children who cannot sit up unassisted, the level line on shell **MUST** be parallel with the ground.

For children who can sit up unassisted, you may rotate the child restraint to be more upright.



6. Hook LATCH to Vehicle Anchor



7. Tighten Belt

Place hand in child restraint.

Firmly push child restraint down and back towards the vehicle seat back while pulling free end of belt to tighten.

It may be easier to pull pad away from shell and tighten the belt through the belt path opening as shown.

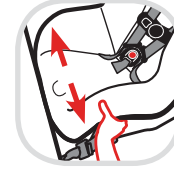

8. Check Belt Tightness

Hold child restraint at the belt path with your weakest hand.

Push and pull from side to side.

If it moves more than 1 in. (2.5 cm), try pulling the belt tighter, try reinstalling the child restraint, try another seating location, or switch to using the vehicle belts.



9. Secure Child in Child Restraint

Recheck level line.

Repeat steps 5-8 if level line is not parallel with the ground.



You may need to place a large rolled towel(s) or foam pool noodle(s) under front of child restraint to help make level line parallel with the ground.

Check often to be sure padding is still in place and the belt is tight.



To Release LATCH Remove child from child restraint.

Remove tension from LATCH belt by pushing down on side of child restraint with LATCH adjuster. Then press adjuster button to loosen belt. Unhook LATCH from bar by squeezing

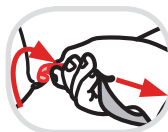

spring lever, pushing back into the seat bight and twisting the hook. Then pull it out of the vehicle seat.

Store LATCH when not in use. See page 25.

Vehicle Belt Installation

⚠ WARNINGS: Do not use LATCH belts along with the vehicle lap or lap/shoulder belt. Secure LATCH belts as shown when using vehicle belts.



When the child restraint is used rear facing, you **MUST** secure the tether hook to the storage attachment and gently tighten to remove slack.

Check vehicle belt before each use. Use only if belt can be tightened properly and locked securely in place.

Failure to follow these warnings can result in serious injury or death.

Safety Tip

Make sure harness and buckle fit your child correctly before installing the child restraint. See pages 3-4.



1. Place Child Restraint Rear Facing in Back Seat

For children who cannot sit up unassisted, the

level line on shell **MUST** be parallel with the ground.

For children who can sit up unassisted, you may rotate the child restraint to be more upright.

continued on next page 36



2. Route Vehicle Lap or Lap/Shoulder Belt Through Rear-Facing Belt Path

Review pages 27-29 and your vehicle owner's manual to determine what kind of vehicle belts you have and how to lock a child restraint in place.

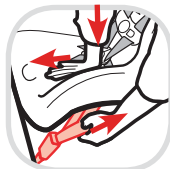

4. Tighten Belt

Place hand in child restraint.

Firmly push child restraint down and back towards the vehicle seat back while pulling free end of belt to tighten.



3. Reach Under Pad and Pull Vehicle Belt Across the Shell

Do not twist belt.

Belt **MUST** be in front of buckle strap. You

MUST use the 1st or 2nd buckle slot. Do not place belt over child's legs. Buckle vehicle belt.

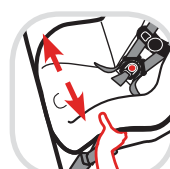

5. Check Belt Tightness

Hold child restraint at the belt path with your weakest hand.

Push and pull from side to side.

If it moves more than 1 in. (2.5 cm), try pulling the belt tighter, try reinstalling the child restraint, try another seating location, or switch to using the LATCH belt if available.



6. Secure Child in Child Restraint

Recheck level line.

Repeat steps 2-5 if level line is not parallel with the ground.



You may need to place a large rolled towel(s) or foam pool noodle(s) under front of child restraint to help make level line parallel with the ground.

Check often to be sure padding is still in place and the belt is tight.



Forward Facing Installation



22-40 lb (10-18 kg)
29-43 in. (73.6-110 cm)
At least 2 years old



LATCH Belt with Tether



Lap/Shoulder Belt with Tether



Lap Belt with Tether



Safety Tip

Experts agree that children should remain rear facing as long as possible.

In this child restraint, your child can remain rear facing up to 40 lb (18 kg) and up to 40 in. (101.6 cm).

⚠ WARNING: In this child restraint your child **MUST** be at least 2 years old before they sit forward facing.

Tether Use

Always attach, adjust, and secure the top anchorage (tether) strap when installing the child restraint forward facing. Tethers improve the installation and stability of child restraints and reduce the risk of injury.

Attach the tether hook to the tether anchor designated by your vehicle manufacturer for that seating position. Check your vehicle owner's manual for more information.

If the seating position does not have a tether anchor, use a different seating position or see your dealer or a qualified mechanic and have one installed. The tether can greatly improve the performance of this child restraint.



To Adjust Tether Strap:



Pull free end to tighten

To tighten: After the child restraint is locked into place with LATCH or vehicle belt, push down on child restraint and gently pull on free end of tether.

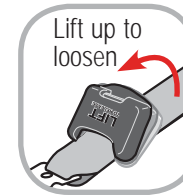

Lift up to loosen

To loosen: Lift up on tether lock adjuster and push it towards tether hook.



LATCH Installation

⚠ WARNINGS: Do not use LATCH belts along with the vehicle lap or lap/shoulder belt.

Check LATCH belt before each use. Use only if the belt can be tightened properly and securely.

Do not fasten both LATCH hooks on same LATCH anchor bar in the vehicle.

Failure to follow these warnings can result in serious injury or death.

Safety Tip

Make sure harness and buckle fit your child correctly before installing the child restraint. See pages 3-4.

Review your vehicle owner's manual for LATCH belt use and LATCH locations.

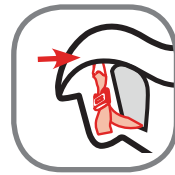

1. Remove LATCH from Storage Location

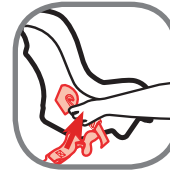

2. Route LATCH Belt Through Forward-Facing Belt Path

Do not twist belt.

LATCH adjuster can be on either side.



4. Place Child Restraint Forward Facing Flush Against Vehicle Seat Back

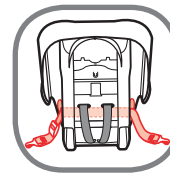

3. Finished LATCH Routing

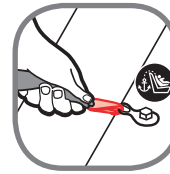

5. Loosely Attach Tether Hook

Check vehicle owner's manual for specific location.



6. Hook LATCH to Vehicle Anchor



It may be easier to pull pad away from shell and tighten the belt through the belt path opening as shown.



7. Tighten Belt

Place knee in child restraint.

Firmly push down while pulling free end of belt to tighten.



8. Tighten Tether

With knee still in child restraint, push firmly on the back of the seat and tighten tether strap.



9. Check Belt Tightness

Hold child restraint at the belt path with your weakest hand.

Push and pull from side to side.

If it moves more than 1 in. (2.5 cm), try pulling the belt tighter, try reinstalling the child restraint, try another seating location, or switch to using the vehicle belts.



To Release LATCH

Remove child from child restraint.

Remove tension from LATCH belt by pushing down on side of child restraint with LATCH adjuster.



Then press adjuster button to loosen belt. Unhook LATCH from bar by squeezing spring lever, pushing back into the seat bight and twisting the hook. Then pull it out of the vehicle seat. **Store LATCH when not in use. See page 25.**



Vehicle Belt Installation

⚠ WARNINGS: Do not use LATCH belts along with the vehicle lap or lap/shoulder belt. Secure LATCH belts as shown when using vehicle belts.

Check vehicle belt before each use. Use only if belt can be tightened properly and locked securely in place.

Failure to follow these warnings can result in serious injury or death.

Safety Tip

Make sure harness and buckle fit your child correctly before installing the child restraint. See pages 3-4.



1. Place Child Restraint Forward-Facing Flush Against Vehicle Seat Back

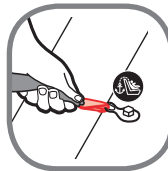

2. Loosley Attach Tether Hook

Check vehicle owner's manual for specific location.



3. Route Vehicle Lap or Lap/Shoulder Belt Through Forward-Facing Belt Path

Review pages 27-29

and your vehicle owner's manual to determine what kind of vehicle belts you have and how to lock a child restraint in place. **Do not twist belt. Buckle vehicle belt.**



4. Tighten Belt

Place knee in child restraint.

Firmly push down while pulling shoulder belt or free end of lap belt to tighten.



5. Tighten Tether

With knee still in child restraint, push firmly on the back of the seat and tighten tether strap.



6. Check Belt Tightness

Hold child restraint at the belt path with your weakest hand.

Push and pull from side to side. If it moves more than 1 in. (2.5 cm), try pulling the belt tighter, try reinstalling the child restraint, try another seating location, or switch to using the LATCH belt if available.



Using a Locking Clip

You will rarely need to use a locking clip except in some older vehicles.

Built-in child restraint locking systems have been required in vehicles since 1996, and many vehicles had these features even earlier. Review pages 27-29 and your vehicle owner's manual to determine if your vehicle belts require a locking clip.

If you need a locking clip immediately, they are likely available at an auto dealership, an auto store, or where you purchased this child restraint. You can also email us at consumer@djgusa.com or call us at 1-800-544-1108 for one.

A locking clip will not fix all types of seat belt problems. You **MUST** have a lap and shoulder belt to use a locking clip.

47

For Rear Facing installation, follow Pages 36-38 Warnings and Steps 1-4 before starting locking clip installation.

For Forward Facing installation, follow Pages 45-46 Warnings and Steps 1-4 before starting locking clip installation.



1. Determine Locking Clip Position

Grasp both vehicle belts together just behind the latch plate to mark the position for locking clip. Unbuckle the belt.

NOTE: If the latch plate ends up just at the belt path opening so you cannot grasp the vehicle belt at the latch plate, grasp the vehicle belts on the opposite side of the child restraint, as close to the latch plate as possible.



2. Attach Locking Clip

Thread both portions of the vehicle belt onto the locking clip, as close to the latch plate as possible.

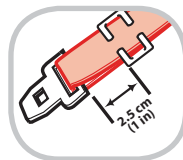

3. Position Locking Clip

It should be about 1 in. (2.5 cm) from vehicle belt's latch plate.

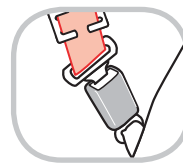

4. Rebuckle Vehicle Belt

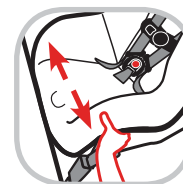

5. Check Belt Tightness

Hold child restraint at the belt path with your weakest hand. Push and pull from side to side.

If it moves more than 1 in. (2.5 cm), try reinstalling the child restraint or try another seating location.

When installed rear facing, recheck the level line.

When installed forward facing, make sure to tighten the tether strap.

Remove the locking clip when the seat belt is not being used with a child restraint.

48

Dorel Juvenile Group Information

Thank you for choosing this child restraint. The DJG family is committed to creating child restraints with the most comfort and convenience available today.

Remember, parents are a child's first teachers and examples. If you always buckle your seat belt, your child will think it is the natural thing to do.

Make it a firm rule that the vehicle does not go until everyone is buckled up. Make no exceptions.

No one can predict if use of a child restraint will prevent injury or death in a particular crash. However, when combined with careful driving, proper use of a child restraint can lower a child's risk of injury or death in most crashes.

Your child's safety is worth the time it will take to read and follow these instructions. After reading, if you still have questions or have any problems with this child restraint, please contact our Consumer Relations Department at:

Website: www.coscokids.com
Email: consumer@djgusa.com
Telephone: 1-800-544-1108
 M-TH from 8 A.M. to 6 P.M. EST
 FRI from 8 A.M. to 4:30 P.M. EST

Mailing Address:
 Dorel Juvenile Group, Inc.
 Consumer Relations Department
 P.O. Box 2609
 Columbus, IN 47202-2609
Fax: 1-800-207-8182

Registration and Safety Notices

Please complete the postage-paid registration card that came with your child restraint, and send it to us. Child restraints could be recalled for safety reasons. You must register this restraint to be reached in a recall. Send your name, address, email address if available, and the restraint's model number and manufacturing date to:

Dorel Juvenile Group, Inc.
Consumer Relations Department
 PO Box 2609, Columbus, IN 47202-2609
 or call 1-800-544-1108 or register online at www.djgusa.com/registration/carseat/us.

For recall information, call the U.S. Government's Vehicle Safety Hotline at 1-888-327-4236 (TTY: 1-800-424-9153), or go to <http://www.NHTSA.gov>.

Model Number	Model Name	Manufacture Date
BC098-BVM	COSCO SCENERA NEXT	01/22/2015

L#11 8265035

Example of model number, manufacture date, and line code.



If you don't have the card or if your address changes, you will find the model number, manufacture date, and line code on the label located on side of shell.

Troubleshooting

1. Locate a Child Safety Seat Inspection Station for hands on training on how to use your child restraint:

Visit your local Child Passenger Inspection Station or go to <http://www.safercar.gov/cpsApp/cps/index.htm> to find your closest station.

2. If the child restraint buckle or harness release lever sticks or you cannot get the straps tight enough around child:

DO NOT LUBRICATE. Check around lever and retractor for dropped food, sticky spilled drinks, dirt, leaves, etc. Clean with warm water and/or remove object with tweezers. If you cannot get the harness to adjust and remain tight with the buckle securely locked, do not use the child restraint.

3. If you cannot insert the buckle tongues into buckle, switch sides and try again.

4. If your harness twists:

Straighten the harness each time you put your child in the child restraint to help prevent twisting. Lock the buckle and tighten harness and it will be ready for next use.

Replacement Parts Order Form

Complete the form. Your model number and manufacturer date code **MUST** be included on the form to ensure proper replacement parts. The codes can be found on a label on side of child restraint. Payment in U.S. dollars must accompany your order. Choose parts needed from the list on the next page. Return the form with payment to:

Dorel Juvenile Group, Inc.
Consumer Relations Department
P.O. Box 2609
Columbus, IN 47202-2609

Fax orders to: 1-800-207-8182

Please make money orders payable to Dorel Juvenile Group, Inc. Fill in the area on the next page to charge credit card. (Visa or MasterCard **only**). We do not accept cash, personal checks, or other credit cards. All outside of U.S. and Canada **MUST** use credit card.

Ship To: (Please Print)

Name: _____

Address: _____

City: _____

State/Province: _____ Zip: _____

Telephone: _____

Email Address: _____

We **MUST** have this information:

Model Number (8 to 9 characters):

Manufacture Date (mm/dd/yyyy):

Replacement Parts List

NOTE: If requested color is not available, similar color will be substituted. Prices are subject to change.

Part	Cost	Qty	Total Cost
Buckle Assembly	\$7.99	...	\$
Harness Strap	\$2.99	...	\$
Seat Pad	\$24.00	...	\$
Chest Clip	\$1.50	...	\$
Tether Kit	\$6.50	...	\$
LATCH Kit	\$7.99	...	\$
Instructions	\$0.00	...	\$
Locking Clip	\$2.50	...	\$

Merchandise Total \$

Shipping and handling:..... \$

Up to \$25.00.....	\$5.95	\$100.01 to \$150.00..	\$10.95
\$25.01 to \$50.00.....	\$6.95	\$150.01 to \$200.00..	\$11.95
\$50.01 to \$75.00.....	\$8.95	\$200.01 and up	\$13.95
\$75.01 to \$100.00....	\$9.95	Outside Continental USA	\$10.00

Sales Tax \$

(Arizona, California, Georgia, Indiana, Missouri, South Carolina, and Texas residents add applicable sales tax.)

Grand Total \$

No shipping and handling on instructions for quantities under 6. Add \$.50 for each instruction over 6, then add applicable shipping and handling.

Fill Out For Credit Card
 Visa MasterCard

Card Exp. Date: _____

Cardholder's Name: _____

Card Number: _____

Signature: _____

CUT ON DOTTED LINE

Warranty

Dorel Juvenile Group, Inc. (DJG) warrants this product to the original retail purchaser as follows: This product is warranted against defective materials or workmanship for one year from the date of original purchase. **An original receipt is required to validate your warranty.** DJG will, at its option, provide replacement parts or replace this product. DJG reserves the right to substitute if the part or model has been discontinued.

To make a claim under this warranty you may email us at consumer@djgusa.com; fax us at 1-800-207-8182 24 hours a day; write to DJG, Consumer Relations Department, P. O. Box 2609, Columbus, IN 47202-2609; or call 1-800-544-1108 from 8:00 a.m. to 6:00 p.m. EST Monday through Thursday and from 8:00 a.m. to 4:30 p.m. on Friday. Proof of purchase is required and shipping charges are the responsibility of the consumer.

Warranty Limitations: This warranty does not include damages which arise from

misuse or abuse of this product. **Limitation of Damages:** The warranty and remedies as set forth are exclusive and in lieu of all others, oral or written, expressed or implied. In no event will DJG or the dealer selling this product be liable to you for any damages, including incidental or consequential damages, arising out of the use or inability to use this product. **Limitation of warranties and other warranty terms and state law rights:** Any implied warranties, including implied warranties of the merchantability and fitness for a particular purpose, shall be limited to the duration and terms of the express written warranty. Some states do not allow limitations as to how long an implied warranty lasts or the exclusion or limitation of incidental or consequential damages, so the above limitations may not apply to you. This warranty gives you specific legal rights, and you may have other rights, which vary from state to state. Neither DJG nor the dealer selling this product authorized any person to create for it any other warranty, obligation, or liability in connection with this product.